

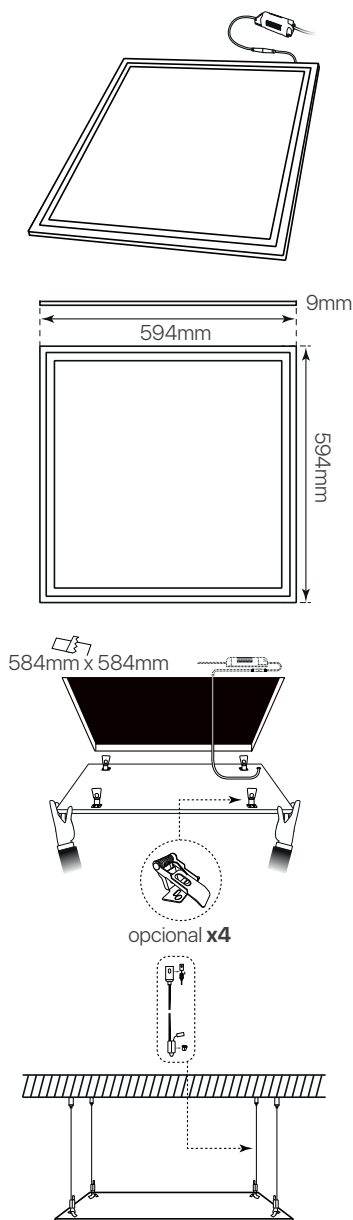

eco mode 
 ficha técnica
 datasheet



ref. 5550622



Nombre / Name	Eco mode  • panel led
Referencia / Reference	5550622
Materiales / Materials	Aluminio + PMMA / Aluminum + PMMA
Difusor / Diffuser	PMMA
Potencia / Power	40W
Temperatura de color / Color temperature	6500K
Flujo luminoso / Luminous flux	3700lm
Dimable / Dimmable	Opcional, consultar / Consult us
Ángulo de apertura / Beam angle	120°
Ángulo de detección / Detection angle	-
IP	40
IK	07
F.P	>0.9
UGR	≤19
IRC	>80
Chip	EPISTAR 4014
Driver	i-TEC series
Vida media (duración) / Average life	± 30.000h
Clase energética / Energy class	A+
Aislamiento eléctrico / Electrical isolation	Clase I / Class I
Colores / Colors	Blanco / White
Medida exterior / Product size	594mm x 594mm x 9mm
Medidas de corte / Cutting measurements	584mm x 584mm
Tª (ambiente/trabajo) / Tª (environment/work)	-10°C ~ 45°C
Input	AC110 ~ 249V
Output	DC27 ~ 42V 1000mA ±5%
Frecuencia / Frequency	50 / 60Hz
Peso / Weight	1,87kg
Certificados / Certificates	CE RoHS
Garantía / Warranty	2 años / 2 years